

PHOTOVOLTAIC MODULE INSTALLATION INSTRUCTIONS

1. INTRODUCTION

- BEFORE INSTALLATION, OPERATION, AND MAINTENANCE, BE SURE TO READ THESE INSTRUCTIONS AND USE THE PV MODULE SAFELY.
- FOR INSTALLATIONS IN THE USA, REFER TO THE NATIONAL ELECTRIC CODE (NEC) AND ALL APPLICABLE LOCAL CODES. FOR INSTALLATIONS IN CANADA, REFER TO THE CANADIAN ELECTRIC CODE (CEC) AND ALL APPLICABLE LOCAL CODES.
- FAILURE TO OBSERVE THE FOLLOWING INSTRUCTIONS MAY RESULT IN DEATH OR PERSONAL INJURY AND PROPERTY DAMAGE.
- KEEP THIS MANUAL FOR FUTURE INSPECTION.

⚠ WARNING

1. GENERAL USE

- Avoid touching the front surface of the module with bare hands.
- Do not handle except for installation and maintenance.
- Ensure that unauthorised personel, including children, cannot get access to the modules.

2. GENERAL HANDLING

- DO NOT alter or remove any component.
- DO NOT stand or step on a module.
- DO NOT damage the front or rear surface of the PV module. The rear surface may be damaged by sharp objects.
- DO NOT throw or drop the PV module.
- DO NOT lift the module by the connectors or cables.

3. INSTALLATION

- Only licensed professionals should handle the modules.
 - Secure yourself to avoid falling from the installation area.
 - DO NOT use damaged the PV modules.
- A damaged PV module may cause a fire and/or an electrical shock with personal injury or even death.

- DO NOT expose the PV module to artificially concentrated sunlight.
- Cover the front surface of the PV modules with an opaque cloth to prevent the generation of high voltage and current during installation.
- Fasten the PV modules to the mounting framework securely to prevent the modules from falling due to wind or snow loads. The modules should be installed as written in this installation manual.
- Securely ground the PV module frame and the mounting framework where local regulations require this.
- Install a residual current device (RCD) as prescribed by the local regulations.
- DO NOT expose backside of the module to the sunlight.
- Do not install the modules in places where they can be shaded by objects such as buildings and trees.

ELECTRICAL SPECIFICATIONS

MODEL	Pmax	Voc	Isc	Vmp	Imp	*1 [A]	*2 [A]	MAXIMUM SYSTEM VOLTAGE
PV-MLE255HD	255 W	37.8 V	8.89 A	31.2 V	8.18 A	15	12.5	600V (UL), 1000V (IEC) (IEC61215, IEC61730, UL1703)
PV-MLE260HD	260 W	38.0 V	8.98 A	31.4 V	8.29 A	15	12.5	
PV-MLE265HD	265 W	38.2 V	9.08 A	31.7 V	8.38 A	15	12.5	
PV-MLE270HD	270 W	38.4 V	9.18 A	31.9 V	8.48 A	15	12.5	
PV-MLE275HD	275 W	38.6 V	9.28 A	32.2 V	8.58 A	15	12.5	
TOLERANCE	*3	-	-	-	-	-	-	-

The electrical characteristics are within $\pm 10\%$ of the indicated values of I_{sc} , V_{oc} , and within $+5/-0\%$ of P_{max} under standard test conditions (irradiance of 1000 W/m^2 , AM1.5 spectrum, and a cell temperature of 25°C (77°F)).

Standard: IEC61215 ed. 2 (2005), IEC61730 ed. 1 (2004) Application Class A, UL1703

SYMBOLS DEFINITION

Pmax	MAXIMUM POWER	*1	FUSE RATING BASED ON MAX. BYPASS DIODE AMPACITY WITHIN PV MODULE
Voc	OPEN CIRCUIT VOLTAGE	*2	MINIMUM BYPASS DIODE RATING
Isc	SHORT CIRCUIT CURRENT	*3	+5/-0% OF NOMINAL VALUE
Vmp	MAXIMUM POWER VOLTAGE		
Imp	MAXIMUM POWER CURRENT		

1-1. STRUCTURE

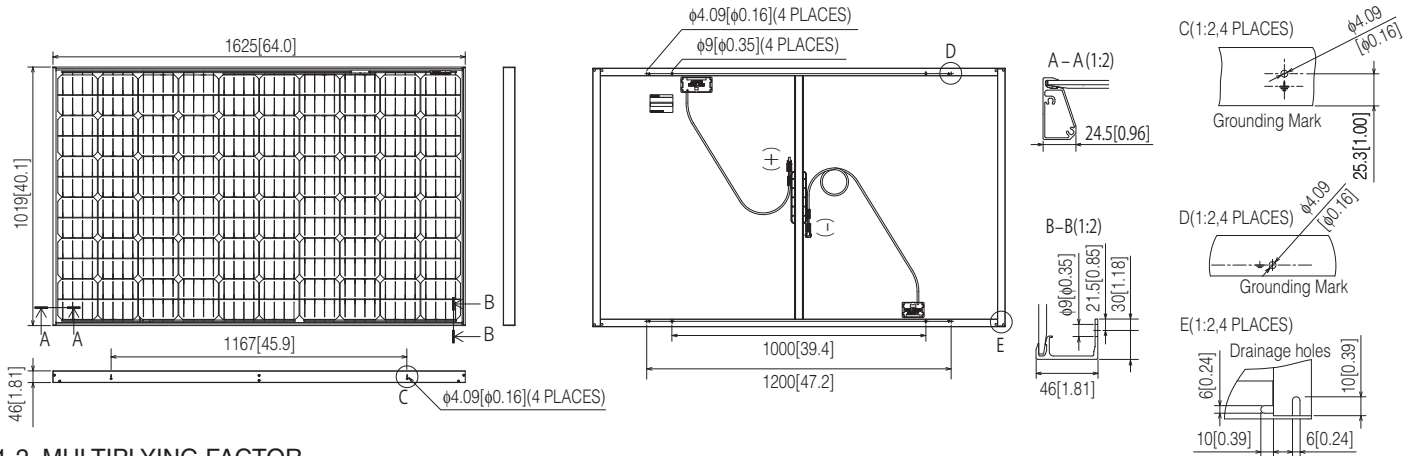

1-2. MULTIPLYING FACTOR

Under normal conditions, the PV module is likely to experience conditions that produce more current and/or voltage than reported under Standard Test Conditions. Accordingly, the values of I_{sc} and V_{oc} marked on this module should be multiplied by a factor of 1.25 when determining component voltage ratings, conductor capacities (cross sectional area), fuse sizes, and size of controls connected to the PV output. Customers in US should refer to Section 690-8 of the National Electrical Code for an additional multiplying factor of 125 percent (80 percent derating), which may be applicable. Customers in other location should refer to the codes relevant to the location of installation for further guidance. V_{oc} should be increased by a factor based on the lowest ambient temperature recorded for the location. To determine the corrected value for Maximum System Voltage follow the guidelines in article 690.7 of the NEC or applicable section in the CEC. The voltage temperature coefficient for the module in use, should be used when determining Maximum System Voltage.

2. INSTALLATION

Refer to Local Code (US: National Electrical Code) standards (Germany: DIN standards), construction rules and safety instructions for installation of the PV module. The electrical installation in Canada shall be in accordance with CSA. C22. 1, Safety Standard for Electrical Installations, Canadian Electrical Code, Part 1.

2-1. CLIMATE CONDITIONS

Install the PV module within the following conditions:

- Ambient temperature: -20°C to 40°C (-4 to 104°F)
- Operating temperature: -20°C to 83°C (-4 to 181°F)
- Allowable pressure: below 3600Pa
- Water resistance/damage: PV modules shall not be immersed in water and shall not be continually exposed to water from a sprinkler, fountain, etc.
- Corrosion warning: PV module shall not be installed in corrosive area like,
 - Salty area: area where salty water such as ocean spray comes in direct contact with the module, or
 - Sulfurous area: area near sulfurous volcano and sulfurous spring.

Note

In case of installation in Asian countries, PV module also shall not be installed in corrosive area where within 500m from a body of salt water and/or area where salty wind hit directly.

2-2. ORIENTATION

- Install the PV modules facing South (in North Hemisphere), or to the North (in South Hemisphere).
- PV modules connected in series should be installed at the same orientation and angle. Different orientation or angles may cause loss of output power due to the different amount of sunlight exposed to each of the modules.
- Do not allow the modules to be shaded at anytime. Shade causes loss of electrical output, even though the factory fitted bypass diode of the PV module will reduce such loss to some extent.

2-3. MOUNTING

⚠ WARNING

- Use mounting framework that can withstand forces from wind pressure and snowfall pressure specific to your local climate.
- Use mounting framework and brackets that can withstand the environment where the PV modules are to be used. Select proper corrosion resistant materials and coatings.
- Use appropriate safeguards and components to install the modules.
- PV modules shall be mounted over a fire resistant roof covering rated for the application and on any slope less than 5in/ft (127mm/305mm) to maintain a fire Class rating.

⚠ CAUTION

- Make sure there is enough space for air circulation behind the PV modules to dissipate heat. Minimum 89mm (3.5 inches) standoff height must be provided.
- DO NOT open any additional holes in the modules.
- The module is Class C fire rated.

2-3-1. Mounting using bolt holes

Examples of mounting method:

- Use the 4 corner holes of the PV module to bolt with M8 (5/16") stainless steel to the mounting framework by 4.5 to 6N·m (3.3 to 4.4 ft-lb).
- Use spring washers and flat washers to fasten the PV module.
- Install the PV module securely such as fastening the appropriate bolts with double nuts and locking washers.
- Space more than 5 mm between 2 modules (to prevent from buckling a frame of module affected by thermal expansion).

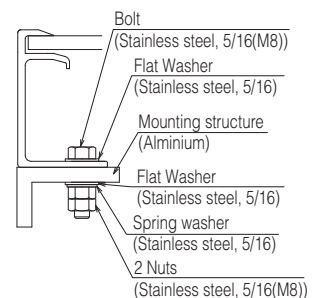

Fig. 1 Mounting of module

2-3-2. Mounting using "Clipping method"

"Clipping method" is the way to fix modules on the steady base profiles (rail structure etc.) with the "clipping" materials to catch the top of the frame, not to directly fix with bolts and nuts on the backside of module. Mitsubishi Electric Corp doesn't specify or warrant any materials, e.g. base profile and clipping materials etc., related to clipping method.

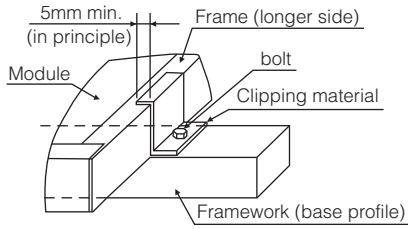
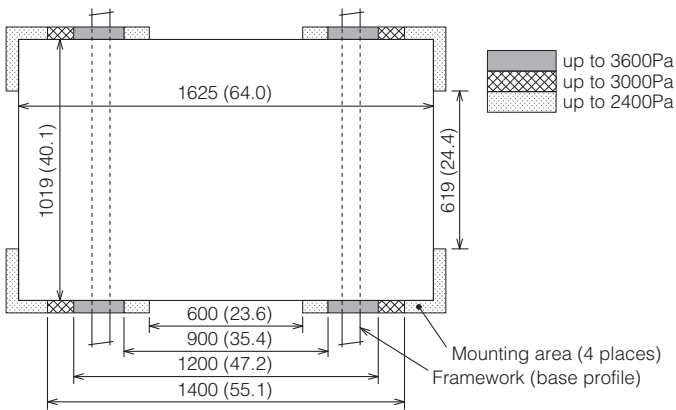

Fig. 2 Clipping method

CAUTION

- Note that the drainage hole at each corner of module would not be blocked by the base profile if the profile were placed in parallel to the longer frame.
- Base profile should be placed in perpendicular to the longer frame of module in principle (see figure).
- Module shall be fixed at 4 places or more on frames.
- Refer to the figure for the required area to be fixed.
- Close the gap between the material and frame, and secure without loosening by M6 (1/4") or larger bolts (M8 (5/16")) for where the heavy snow load is expected.
- The hooked area should be more than 5mm at least.
- Use the clipping material with sufficient strength and the shape that can withstand forces from wind pressure and snowfall pressure specific to local climate.
- Secure bolts with the appropriate torque avoid deformation of the module frame.
- Take pre-caution utilizing locking fasteners to avoid movement of the module from its original anchored position.



Required mounting area to be fixed

2-4. GROUNDING

WARNING

- The grounding method should satisfy the Local Code and the NEC or CEC accordingly.
- Securely ground the PV modules and the mounting framework.

Examples of proper grounding technique:

2-4-1. Method #1 (use of self-tapping screw)

- Secure the stainless steel screw (M5 or No.10) with 32 threads per inch to the grounding hole by 2.3N·m (20lbf-in).
- Ensure that 2 threads are engaged in the module frame.
- As shown in the figure 3, copper wire should be compressed by the screw head.
- Stainless steel washer with appropriate corrosion resistant coating should be inserted between copper wire and screwhead.
- Proper cupped washer should be inserted between copper wire and frame to avoid galvanic corrosion.
- Copper wire must have the thickness of #14 AWG or thicker, and be secured with the module frame.

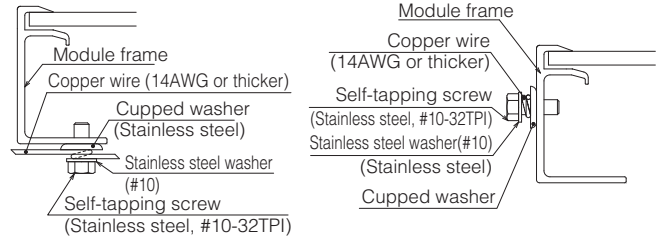

Fig. 3 Grounding method #1

2-4-2. Method #2 (use of ground lug)

- The appropriate device such as UL Listed ILSCO ground lug, Cat. No. GBL4-DBT should be secured by stainless steel screw (M5 or No.10) with 32 threads per inch by 2.3N·m (20lbf-in) as shown in the figure 4.
- The star or toothed washer shall be inserted between ground lug and module frame.
- Copper wire must have the thickness of #14 AWG or thicker, and be secured with the screw of ground lug.

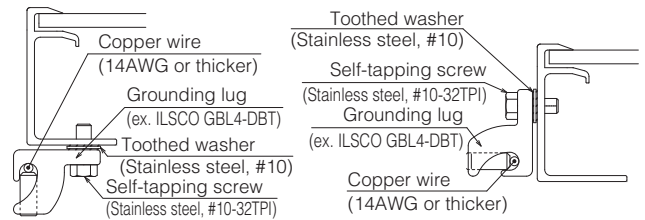

Fig. 4 Grounding method #2

2-4-3. Method #3 (use of bolt and nut)

- Stainless steel bolt and nut of No.8 with 32 threads per inch can be used instead of No.10 self-tapping screw in Method #2 under the following conditions.
 - Torque to secure bolt: 1.8N·m (16lbf-in)
 - Lock or spring washer shall be inserted between nut and toothed washer.

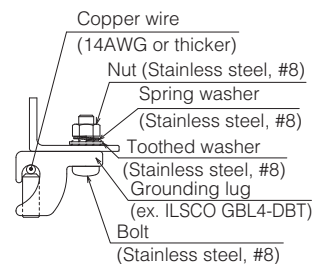

Fig. 5 Grounding method #3

2-4-4. Method #4 (use of bolt and nut for mounting hole)

- All hardware used in this method must be stainless steel.
 - Examples of acceptable grades of stainless steel are 18-8, 316, and 410
- 1 1/4" bolt and double nuts of No.5/16 diameter (or M8) shall be used to mount the PV module to the mounting structure through the mounting hole (which has a diameter of 9mm).

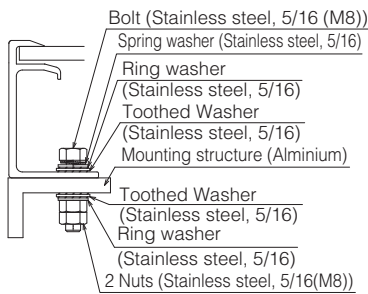

Fig. 6 Grounding method #4

- Torque to secure bolt: 5N·m (3.7 ft-lb)
- External toothed stainless steel washers shall be inserted between the module frame and ring washer, and also between mounting structure and ring washer.
- Spring washer shall be used to avoid loosening of bolt
- All 4 mounting holes of each PV module must be secured to the mounting structure
- 2 of the 4 locations must have external toothed washers utilized
- All four locations shall have 2 nuts installed
- A grounding electrode system for the mounting structure must be provided in accordance with the NEC or CEC accordingly.
- Recommended mounting structure characteristics;
 - Alloys with resistivity less than 1.61 micro-ohms / inch
 - Wall Thickness of at least 1/8"

2-4-5. Method #5 (WEEB clips/ barbed washers and associated racking)

- Barbed washers listed to UL467 intended for use in bonding photovoltaic modules to mounting structures may be used for grounding as described in NEC or CEC accordingly.
- When installing the WEEB UMC Clip or UniRac UGC-1 Clip, as a means of grounding the modules, tighten the mounting bolt to 13.5N·m (10lb-ft).
- Barbed washers identified for grounding must be installed in accordance with the manufacturer's specified instructions.
- Recommended mounting structures that accommodate barbed washers are manufactured by UNIRAC.
- Approved options of WEEB clips/ barbed washers to be used in conjunction with UNIRAC racking solution are:
 - o WEEB UMC clip
 - o UNIRAC UGC-1 clip

Note: Barbed washers are intended for one time use only.

If a module is removed, replaced, repositioned or remounted, the associated barbed washer(s) must be replaced. Follow instructions of the manufacturer.

2-5. WIRING

⚠ WARNING

- DO NOT short the positive and negative cables.
- Make sure connectors are fully engaged without a gap between the insulators and shall be locked. In case there is a gap, a fire and/or an electrical shock may occur.
- Use the appropriate tool provided by SMK for disconnection.

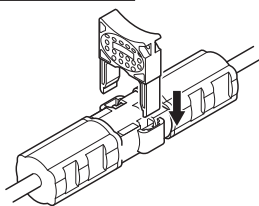

⚠ CAUTION

- Connect required number of PV modules to meet the voltage specification of equipment used in system.
 - [Recommendation (see the enclosed specification sheet, too)]
 - Max. series: 12pcs due to max. system voltage
 - Max. parallel: 2 strings due to fuse rating
- Connect the output cable connectors so that they do not exert any force on the base of the cable at the junction box. Attach the cable to the mounting framework using approved fasteners.
 - The connectors should be placed behind the mounting framework so that the connectors are not directly exposed to sunlight, wind and rain.
- Do not apply external force (stepping, etc) to the connector.

- The PV module has a pair of male and female waterproof connectors. For a series electrical connection, connect the positive (+) connector of the first PV module to the negative (-) connector of the following module.
- These modules employ UL Recognized connectors for the output wiring. Final output field wiring should be done with CCT9901-2352F (P51-6) (male), CCT9901-2452F (R51-6) (female) from SMK and minimum 14 AWG copper wire cables rated for 90°C (194°F).
 - These products will allow final system output wiring in accordance with the U.S. National Electrical Code, NFPA 70-2008 or CEC accordingly.
 - Please refer to Article 690 of the NEC for additional guidance.
- To extend the cable, use proper commercial cables and connectors that can withstand outdoor use for long periods. Select the appropriate cable size according to its length to avoid voltage drop.
 - Follow the cable manufacturer's instructions.

3. MAINTENANCE

⚠ WARNING

- Maintenance must be made only by qualified personnel.
- Be sure the circuit breaker is off, if it's applicable. Always use appropriate safety equipment (insulated tools, insulating gloves, etc.).
- Be sure to cover the front surface of the PV modules with an opaque cloth to block sunlight when connecting or disconnecting connectors of modules.

ANNUAL INSPECTION

- Check if nuts, bolts of mounting framework are secure and not loose. Tighten all loose components.
- Check connections of cables, grounding cables and connectors.
- Check all electrical and mechanical connections for freedom from corrosion.
- Check the ground resistance of metal parts such as the module frames and the mounting framework.

Others

- Clean glass surface of module when glass surface is dirty. (Wash or wipe only glass surface of module without using detergent.)



MITSUBISHI ELECTRIC CORPORATION

All Rights Reserved. Copyright©2009: MITSUBISHI ELECTRIC CORPORATION

Printed in Japan
1210875HF4701



* 8 7 5 H F 4 7 0 1 *